

# ONE



*photo: chrome, spiral cable*



## Functions and features:

### Functionality

The ONE heating element allows you to set two temperature levels. An electronic sensor allows the device to keep to a precise temperature. The device shows the current mode using a multi-coloured LED. The heating element is characterized with a very low power consumption in standby mode.

### Timer

The timer automatically turns the heating element off after 2 hours.

### Remote Control

The heating element is capable of wireless IR communication with an external wall controller DTIR or TTIR, which enhances the use of the ONE heating element with additional features.

### Intelligent Building Systems

In the event of a power failure, the heating element remembers the previous setting (last setting used) enabling collaboration with external timers and intelligent building systems.

### Safety

The ONE heating element is equipped with a number of safety features including; a frost protection setting (ANTI-FREEZE), a double protection against overheating and an 'active' protection to prevent overheating when used in a dry radiator. Device displays warning indicators in case of malfunction.

### Design

The heating element has a metal housing available in Chrome or powder coated finish. It is available in 4 four shapes designed to match radiator collectors. The heating element has a single hidden button to activate and change the settings. There are radiators available with the ONE integrated into the radiator where the only part of the ONE that is visible is the status indicator.

### Colour

Available colours: RAL, Terma special colours and chrome.

## Specifications:

Power supply: 230 V / 50 Hz  
 Device protection class: Class I  
 Radiator connection: G 1/2"  
 Ingress protection [IP]: IPx5

## Table configurations:

Example of product code: **WE** **ODL** **04** **T** **CRO** **W**

Element power code    Colour or finish code    Cable type and plug code

Model code    Packaging code

Code elements highlighted in blue

| Model                           | Power [W]      | Packaging     | Colour                         | Cable Type                           |
|---------------------------------|----------------|---------------|--------------------------------|--------------------------------------|
| <b>WE</b> <b>ODL</b> ONE D left | <b>01</b> 120  | <b>T</b> Tube | <b>916</b> White               | <b>W</b> Straight cable with plug    |
| <b>ODP</b> ONE D right          | <b>02</b> 200  |               | <b>CRO</b> Chrome              | <b>P</b> Straight cable without plug |
| <b>OKX</b> ONE 30x30            | <b>03</b> 300  |               | or any colour from Terma       | <b>U</b> Spiral cable with plug      |
| <b>OPX</b> ONE 30x40            | <b>04</b> 400  |               | RAL & special colours palette. |                                      |
| <b>OTL</b> ONE T left           | <b>06</b> 600  |               |                                |                                      |
| <b>OTP</b> ONE T right          | <b>08</b> 800  |               |                                |                                      |
|                                 | <b>10</b> 1000 |               |                                |                                      |

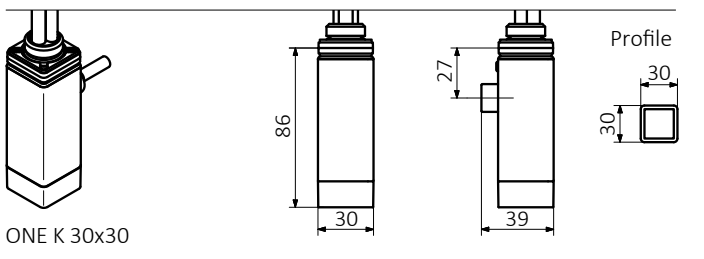
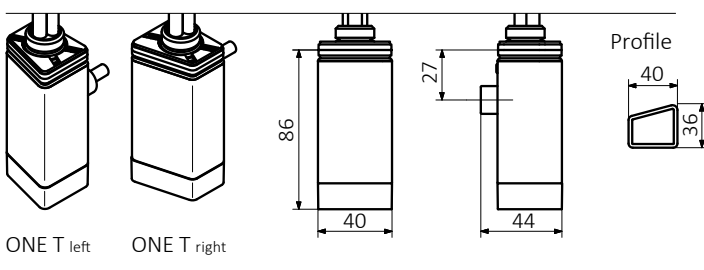
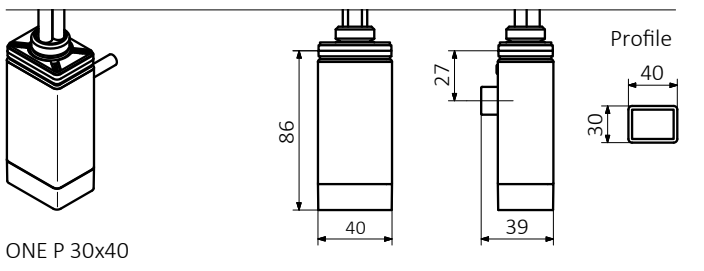
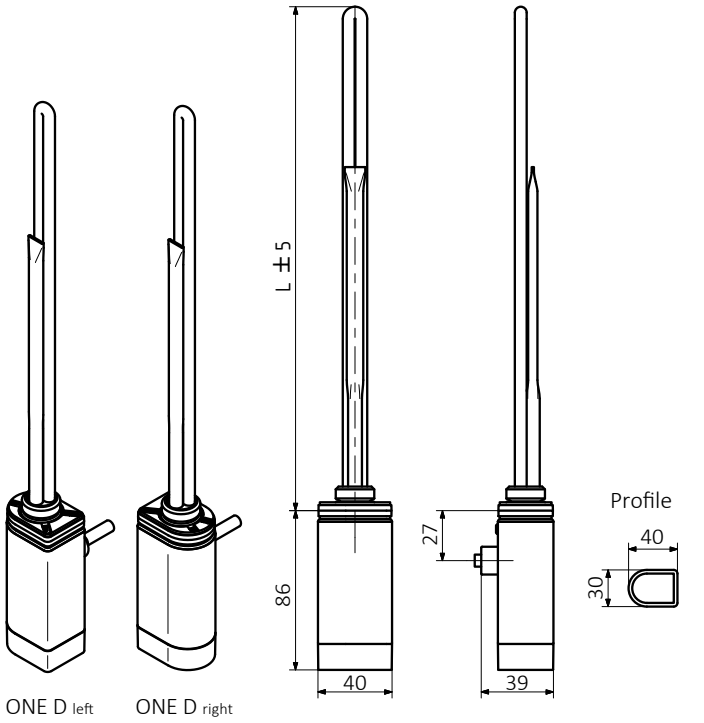

Straight cable without plug

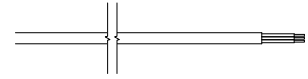

Straight cable with plug

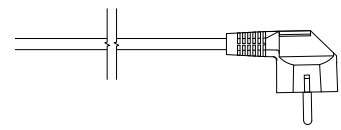

Spiral cable with plug

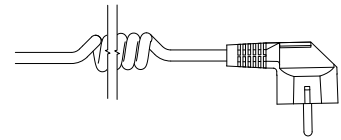

|           |     |     |     |     |     |     |      |
|-----------|-----|-----|-----|-----|-----|-----|------|
| L [mm]    | 310 | 270 | 295 | 330 | 360 | 470 | 560  |
| Power [W] | 120 | 200 | 300 | 400 | 600 | 800 | 1000 |